

## SIDE PANEL

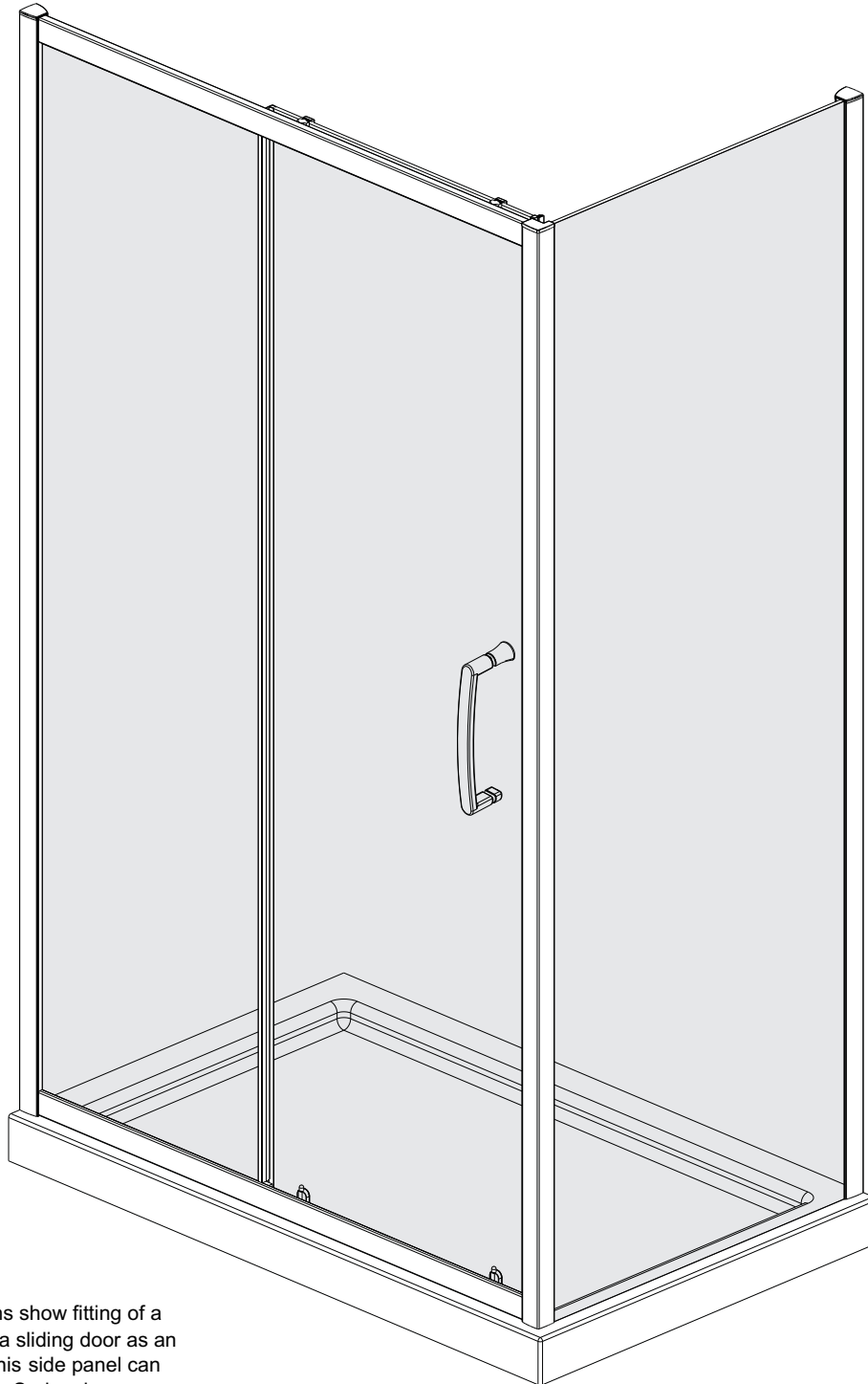

Note: Instructions show fitting of a side panel with a sliding door as an example only. This side panel can be fitted with any Series door.

## INSTALLATION INSTRUCTIONS

## IMPORTANT

Please familiarise yourself with the fitting instructions before commencing fitting.

1. Check that you have the tools required.
2. Check that the installation site is compatible with size of door supplied.
3. Check all the enclosure components.
4. Check that the installation kit is complete.

**DO NOT attempt** to install the product unless you can tick ALL 4 boxes as satisfactory.

The wall plugs supplied with the installation kit are for use in solid walls. Hollow or 'stud-partition' walls will require alternative fixings. Please consult a hardware supplier for the correct type.

It may also be necessary to consult your tiling supplier about the correct method for drilling your tiles.

**USE SAFETY EYEWEAR WHEN DRILLING**

Any parts missing or damaged must be reported to your supplier within 5 days of purchase. Inspect shower enclosure before fitting. No claims will be acceptable after product has been installed.

## COMPONENTS AND BOX CONTENTS

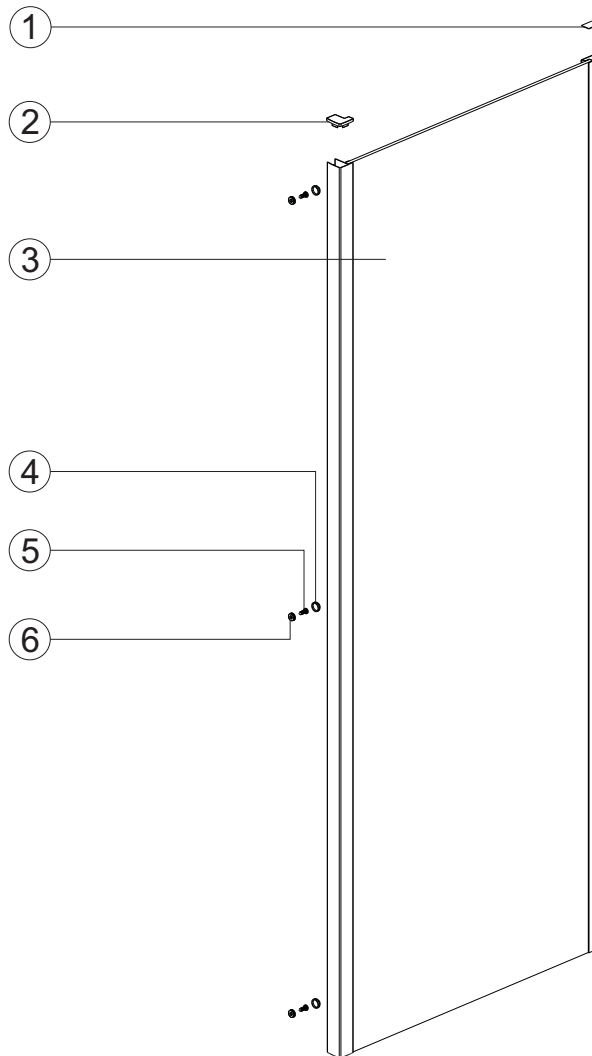

No.	Description	QTY	Part No.
1	Cover cap for upright profile	1	B08062
2	Corner post profile cover L/R	2	B08055L/R
3	Fixed panel	1	A
4	Screw cap	3	A038
5	Corner profile screw ST4x12	3	A2401201
6	Screw clip	3	A039

**Note: Further part details for fixing kit available on page 2**

## FIXING KIT COMPONENTS, TOOLS REQUIRED

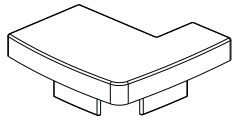

B08055L  
x1

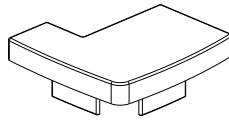

B08055R  
x1

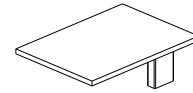

B08062  
x1



A2401201  
x3



A039  
x3



A038  
x3

### Tools Required

- 6mm masonry drill bit
- Spanner
- Power drill
- Quality Silicone
- Pencil
- Tape Measure
- #2 Philips Head screw driver
- Spirit level with horizontal and vertical level indicators

### IMPORTANT-Installation site

1. Ensure the top surface of the shower tray on which the enclosure will be installed is level in every direction.
2. The tiles or other wall finishing should be effectively sealed at the tray edges.
3. Tiles should extend at least to the corners of the tray and a minimum of 2.0 metres from the top of the tray.

# INSTALL FIXED ANEL WALL PROFILE

## PROCEDURE

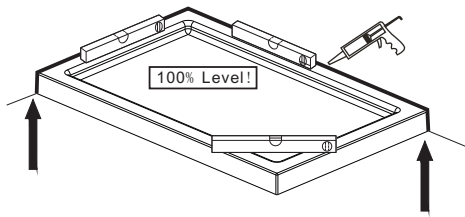

### TRAY MUST BE 100% LEVEL IN ALL DIRECTIONS

Ensure the shower tray is level in all directions and is properly sealed to the wall. The wall must be tiled down to the top edge of the tray. Do not angle out bottom tile.

### TRAY MUST BE SEALED FULLY AROUND WHERE THE TRAY MEETS THE WALL

#### Step 1

Step wall profile in 20mm from edge of tray and plumb. Make sure fixing holes are to the inside. Mark wall through slots in profile.

#### Note:

For installation of the Pivot door, Bifold door or Sliding door, Please see the door instruction manual. Recommended that the sliding door is hinged from a supporting wall and not the side panel.

#### Step 2

Drill holes using 6mm bit and insert wall plugs.

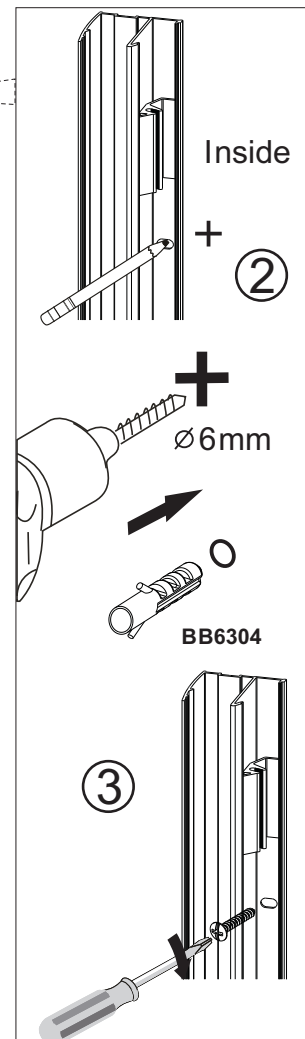
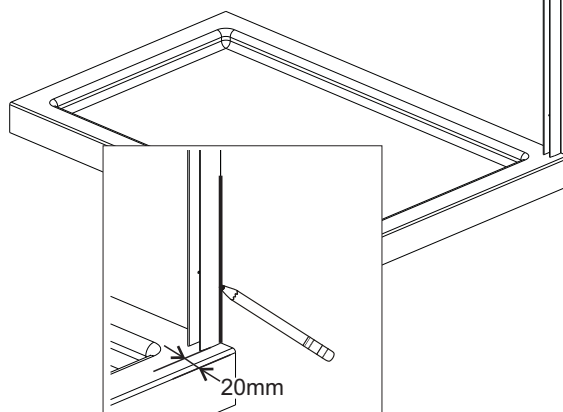

#### Step 3

Fix the wall profile to the wall with screws **A2403001**.

## FIXED FRAMEWORK & INSTALL SIDE PANEL

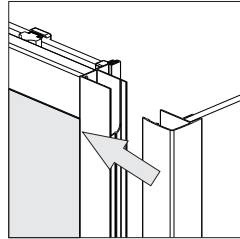
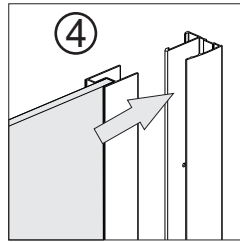
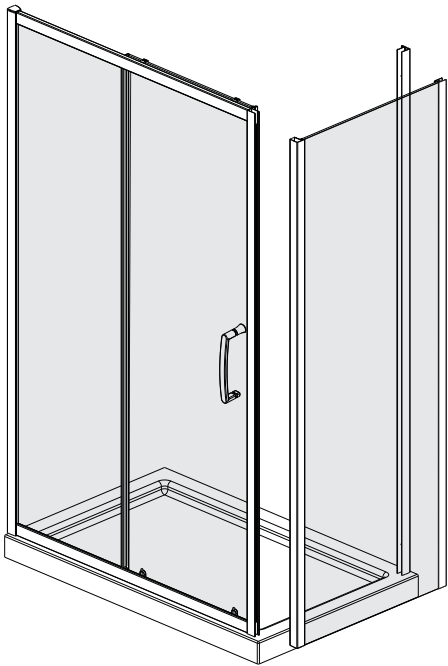

### Step 4

Insert the side panel into the wall profile and also into the frame of the sliding door. Adjust so it is positioned correctly on the tray.

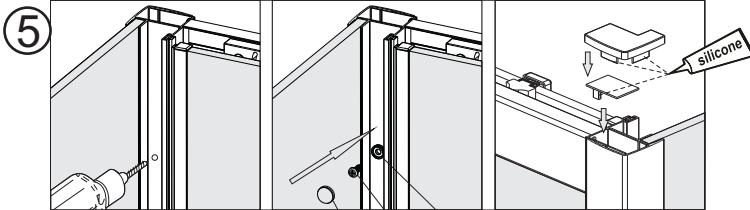

### Step 5

Drill 3 equally spaced holes with 3mm drill bit through the upright profile, corner profile. Fix the frame with screw clip, screws and screw cap. Then fix the upright profile cover and corner profile cover. Place a dab of silicone on the cover cap legs to secure in place.

### Step 6

Drill 3 equally spaced holes with 3mm drill bit through the wall profile and frame. Fix the frame with screws.

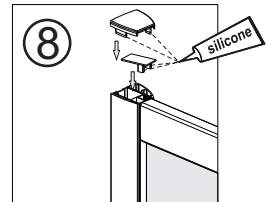
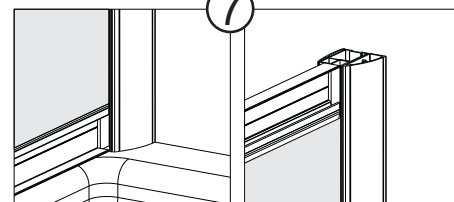
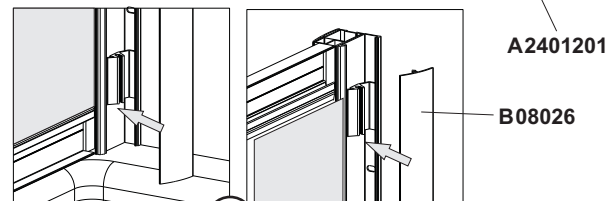
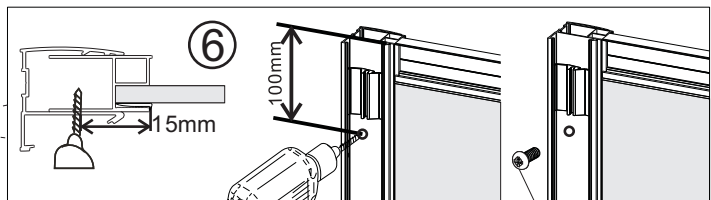
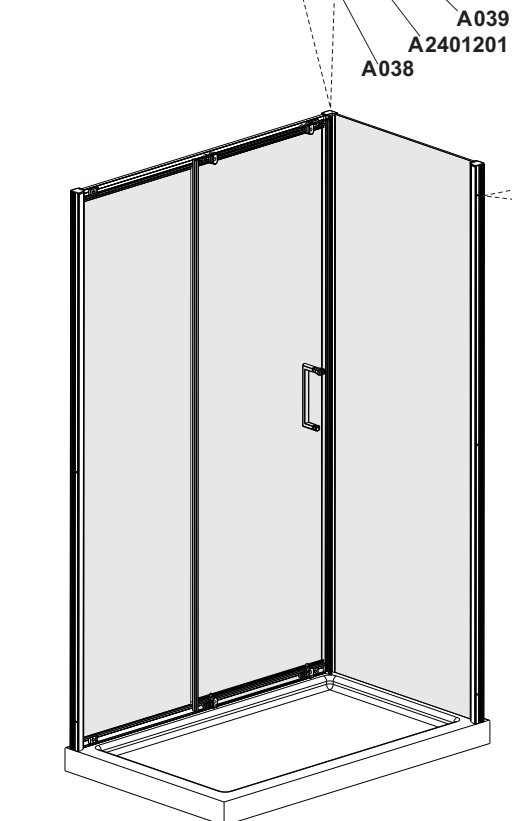

### Step 7

Attach the cover strip **B08026** to the wall profile.

Insert wall profile covercaps followed by the upright profile cover caps. Place a dab of silicone on the cover cap legs to secure in place.

## SEALING

### Step 9

Use a quality silicone sealant to seal the finished door.

#### Sealing Inside

Seal top to bottom on the **INSIDE** between the wall profile and the wall.

Note: Do not apply sealant on inside of tray.

#### Sealing Outside

Seal only along bottom rail on the **OUTSIDE** between profile and the tray and approx 50mm up between the wall profile and the wall. Seal also where bottom profile and frame profile overlap 50mm up.



DO NOT USE THE ENCLOSURE FOR 24 HOURS AFTER SEALING

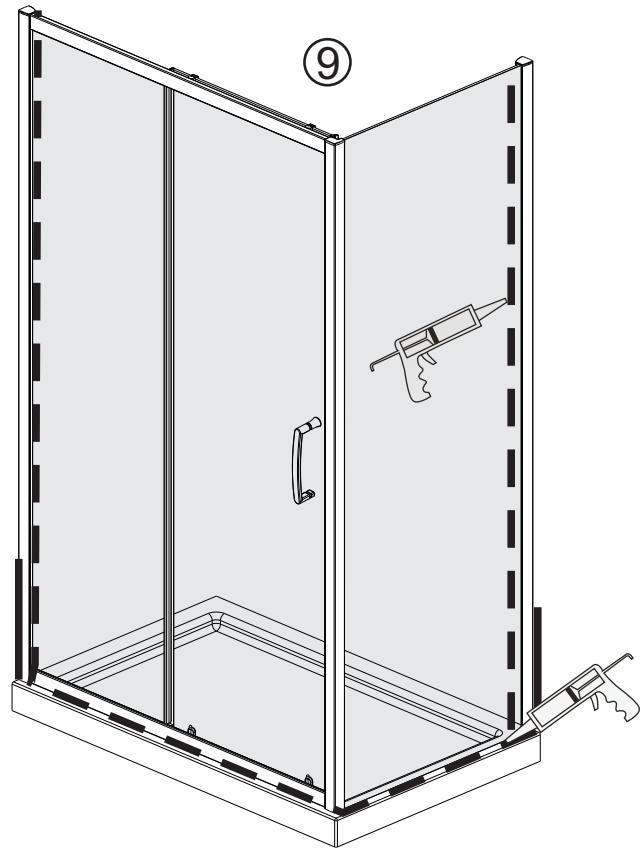

## TROUBLE SHOOTING GUIDE

1. Is the tray level? (See page 3 of the site installation instruction.)
2. Are the wall profiles plumb (Vertically aligned and checked with a spirit level)? (see step 2)
3. Is the unit correctly sealed with silicone? (See step 9)
4. Do the finished measurements on the tray comply with the adjustments listed in the product specifications book?